

Lithium Iron Phosphate (LiFePO₄) Battery

TN-LFP12.8V216AH

FEATURES

- + Using lithium iron phosphate technology, superior safety, thousands of cycles, 100% DOD, under normal conditions.
- + Built-in automatic protection for over-charge, over discharge, over current and over temperature.
- + Free of maintenance .
- + Internal cell balancing.
- + Lighter weight: About 40% ~50% of the weight of a comparable lead acid battery.
- + Can be charged using most standard lead-acid charges (set).
- + Wider temperature range:-20~60 C
- + Support for Series application expansion (up to 51.2V) and two in parallel.

APPLICATION

Recreational Vehicles

Marine

Renewable Energy

Medical / Mobility

Electric Vehicles

Golf Cart

DIMENSIONAL SPECIFICATIONS

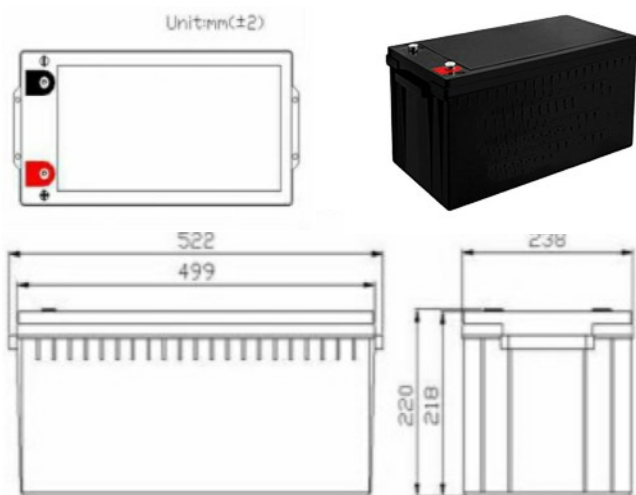

GENERAL SPECIFICATIONS

ELECTRICAL CHARACTERISTICS

Nominal Voltage	12.8V
Nominal Capacity	216Ah@0.2C
Energy	2764Wh
Internal Resistance	35≤mΩ
Cycle Life	2000 Cycles @ 0.2C Charging/Discharging at 100%DOD, End of Life 70% Capacity.
Self Discharge	≤3.5% per month at 25°C

STANDARD DISCHARGING

Discharging Current	21.6A
Max. Continuous Current	100A
Max Pulse Current	200A (<3S)
Discharging Cut-off Voltage	10.0V

STANDARD CHARGING

Charging Voltage 14.6±0.2V	14.0~14.6V
Charging Mode (CC/CV)	At 0 ~45°C temperature, charged to 14.6V at a constant current of 0.2C5A, and then,changed continuously with constant voltage of 14.6V until the current was not more than 0.02C5A
Charger Current	43.2A
Max Charge Current	100A

STRUCTURE

Cell Method	IFR32700 N60, 4S17P
Plastic Case	ABS
Dimension(L*W*H*TH)	522*238*218*220mm
Weight Approx.	28.1Kg
Terminal	M8

OPERATING CONDITION

Charge Temperature	0°C to 45°C (32°F to 113°F) @60±25% Relative Humidity
Discharge Temperature	-20 °C to 60°C (-4°F to 140°F) @60±25% Relative Humidity
Storage Temperature	0°C to 45°C (32°F to 113°F) @60±25% Relative Humidity
Water Dust Resistance	IP55

LITHIUM IRON PHOSPHATE (LiFePO4) BATTERY

TN-LFP12.8V216AH

Different Rate Discharge Curve @ 25°C

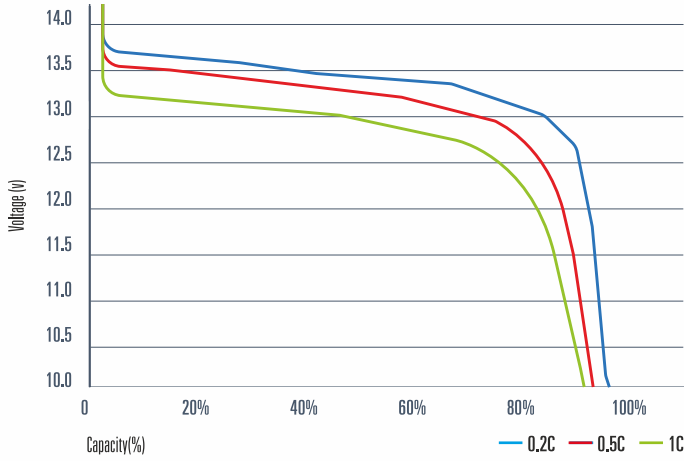

Charge Characteristics @0.2C&0.5C, 25°C

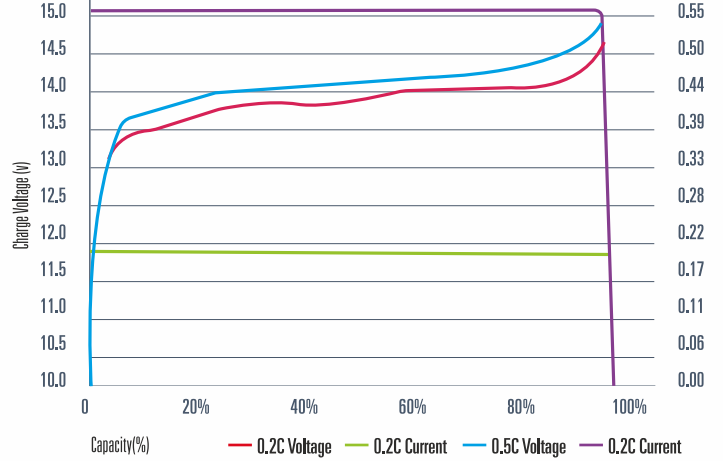

Different Temperature Discharge Curve @0.5C, 25°C

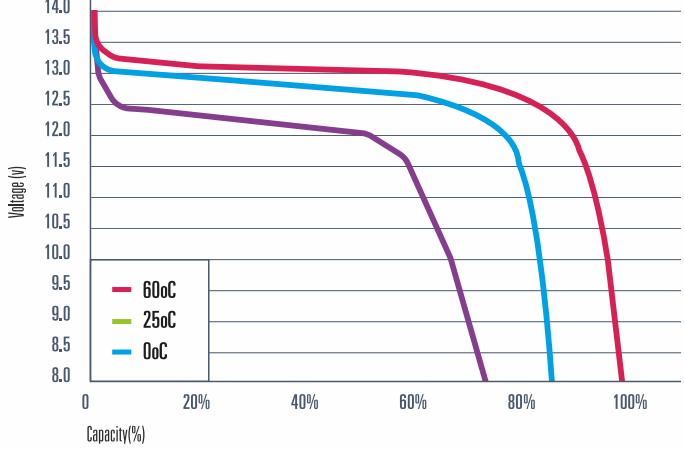

Charge Characteristics @0.2C&0.5C, 25°C

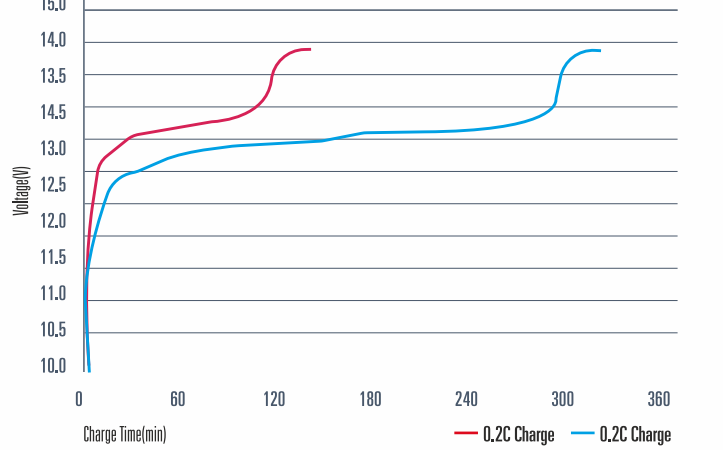

Different DOD Discharge Cycle Life Curve @0.5C, 25°C

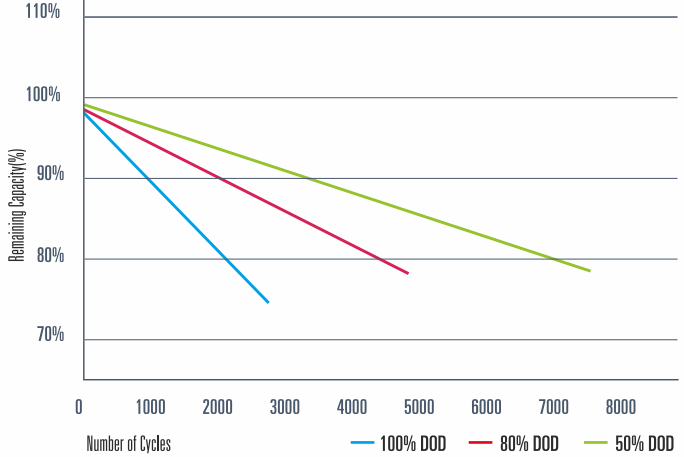

Open circuit voltage VS SOC%

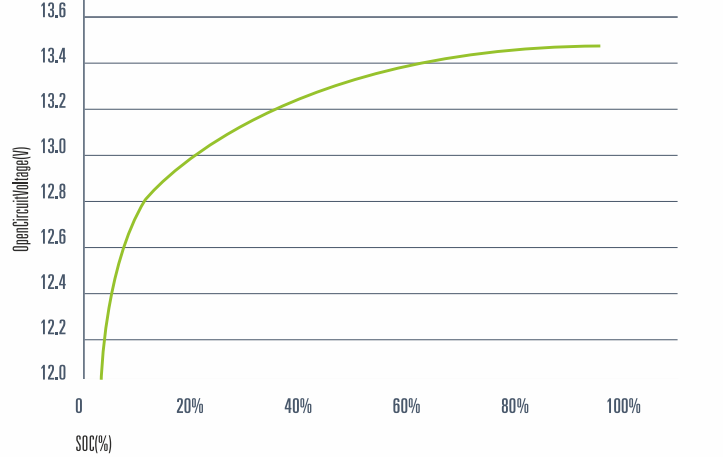

TN POWER Lithium is UN38.3 certified



www.sunshinesolar.co.uk

Sunshine Solar Ltd

Unit 30, Ashwellthorpe Industrial Estate
Ashwellthorpe, Norwich, Norfolk, NR16 1ER